



Min. 15 kg
Max. 250 kg



Min. -20°C
Max. 55°C



+ 2.400 m
- 50 m



Min. 0%
Max. 100%

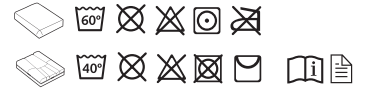

1

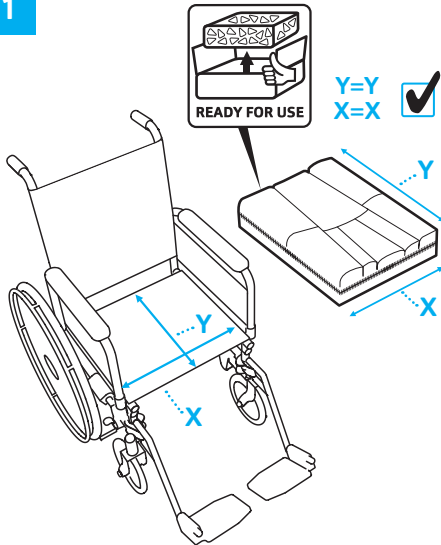

2

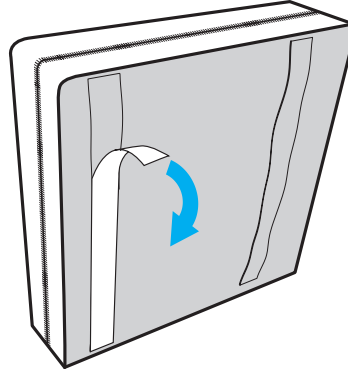

3

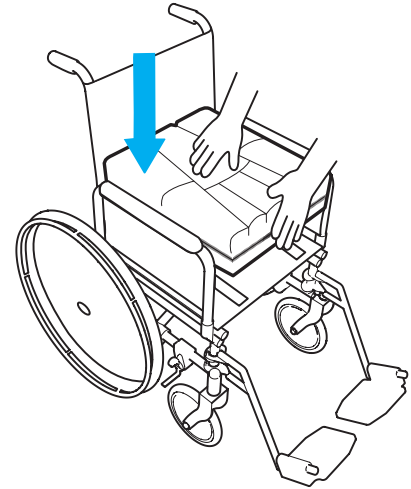

4

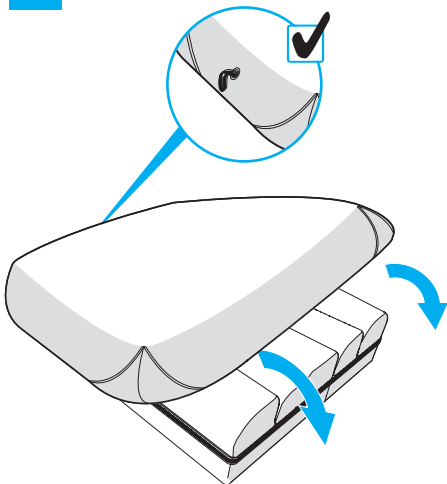

5

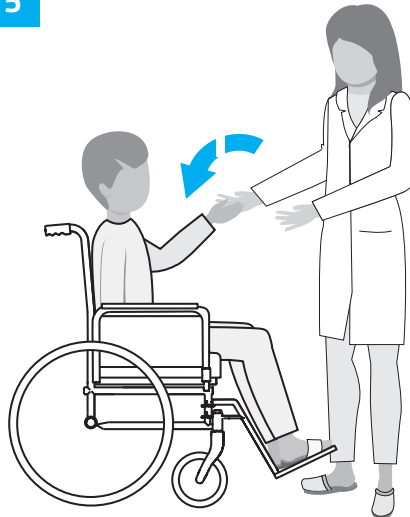

6

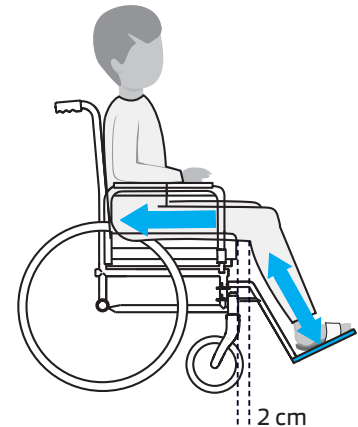

7

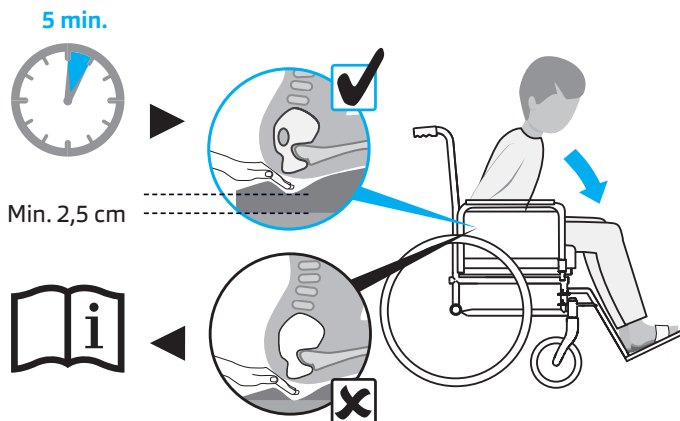

8

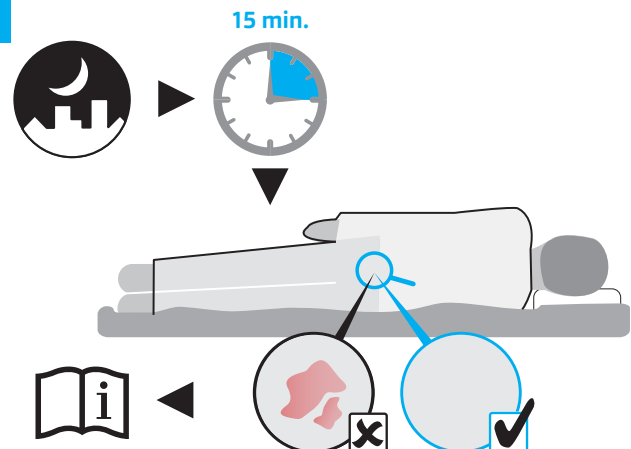

Bruynvisweg 5 1531 AX Wormer Netherlands
info@vicair.com ▲ vicair.com

070101-REV12/2015

