

**Transport Sling (use with Stand-Up Lift)**

Transport slings are for transferring residents with minimal weight-bearing capacity, who have head and neck control, are cooperative, can sit up on the edge of the bed (with or without assistance), and are able to bend at the hips, knees and ankles. Use the R134 and R136 transport sling for transferring resident from bed to chair, chair to car or general in-room transport. Do not raise resident to a full standing position while using the transport sling.

Fits the following lifts : Reliant™ 350, 440, Get-U-Up

Model No.	R134	R136
Size	0	XL
A	34"	46"
B	13.5"	13.5"
C	9"	10"
Weight Capacity	440 lb.	440 lb.

**Standing Sling (use with Stand-Up Lift)**

Standing slings are for residents who are partially dependent, have at least 60% weight bearing capacity, have head and neck control, are cooperative, can sit up on the edge of the bed (with or without assistance), and are able to bend at the hip, knees and ankles. Use the R130 or R131 standing slings for standing assistance, quick toileting, weight bearing practice and for transferring resident from bed to chair, or chair to bed.

Fits the following lifts : Reliant™ 350, 440, Get-U-Up

Model No.	R130	R131
Size	0	XL
A	60"	84"
B	16"	16"
Weight Capacity	440 lb.	440 lb.

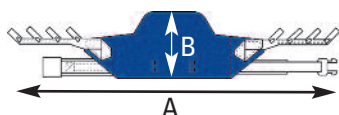

Invacare® Reliant™ Slings

**Warning!**

BEFORE using the Patient Lift, READ and UNDERSTAND the Owner's Manual for proper operation and safety procedures.

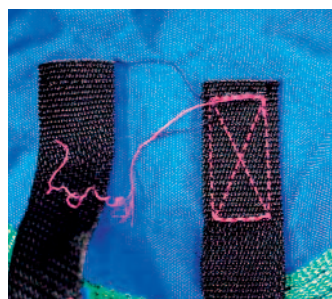

Use the sling that is recommended by the individual's doctor, nurse or medical attendant. Before lifting, check all sling straps for secure points of attachment on lift device. Do not exceed weight limitation posted on lift. Use only with Invacare Patient Lifts. Bleached, torn, cut, frayed or broken slings are unsafe and could result in injury. Discard immediately. Do not alter slings. Use only on Invacare lifts.

**Invacare Corporation**  
www.invacare.com

**USA**  
One Invacare Way  
Elyria, Ohio  
44035-4190  
(800) 333-6900

**Canada**  
570 Matheson Blvd. E.  
Unit 8  
Mississauga, Ontario  
L4Z 4G4 Canada  
(800) 668-5324

© 2009  
Invacare Corporation.  
All rights reserved.  
Trademarks are identified by the symbols™ and®. All trademarks are owned by or licensed to Invacare Corporation unless otherwise noted.

00-266  
Rev. 01/09

# Lifts and Slings

Yes, you can.®

- Battery Powered and Hydraulic Lifts
- Stand-Up and Heavy-Duty Lifts
- Full Assortment of Slings



**Invacare® Lifts and Slings  
Table of Contents**

**Table of Contents**

**Lifts**

<b>NEW</b> Invacare® Premier Series Jasmine™ Full Body Lift	3
Invacare® Reliant™ Series 450 Hydraulic Lift	4
450 Battery Powered Lift	4
450 Lift with Low Base	4
450 Hydraulic Lift	4
450 Power Lift with Power Opening Low Base	5
Invacare® Reliant™ Series Accessories	6
Invacare® Reliant™ Series 600 Heavy-Duty Lift	7 – 8
Invacare® 9805 and 9805P Hydraulic Lifts	9
<b>NEW</b> Invacare® Premier Series Roze™ Stand-Up Lift	10
Invacare® Get-U-Up Hydraulic Stand-Up Lift	11
Invacare® Reliant™ Series 350 Stand-Up Lift	12 – 13
Invacare® Reliant™ Series 440 Stand-Up Lift	14 – 15

**Slings**

<b>NEW</b> Invacare® Premier Series Full Body and Stand-Up Lift Slings	16 – 17
Invacare® Reliant™ Series Full Body and Stand-Up Lift Slings	18 – 20

**NEW**

Optimum functionality. The Jasmine full body lift has innovative features that provide safer resident handling within a 500 pound weight capacity. Caregivers can rely on safer operation and residents on maximum comfort during everyday transfers.

Beyond that, the Jasmine lift expertly functions in more challenging situations with a rotating 360° 6-point hanger bar and 16.4" minimum height range, essential for assisting residents who may have fallen to the floor.

The stable spring-loaded hanger bar produces an audible click when the sling is engaged. This assures the caregiver that the sling is properly attached. And that means less stress for the caregiver, a stable transfer for the resident and less likelihood of injury for both.

Optimized maneuverability is key for a comfortable transfer. Jasmine lifts feature a battery-powered boom and wide-opening base; so caregivers can easily walk behind them and wheelchairs can be accommodated up front. The push handle accommodates any staff member. And with a lighter-weight aluminum and steel construction, control in movement is straightforward and trouble-free.



### Lifting Range

*This lift expertly functions in more challenging situations with a rotating 360° 6-point hanger bar and 16.4" minimum height range, essential for assisting residents who may have fallen to the floor.*



### Maneuverability

*The push handle accommodates any staff member. And with a lighter-weight aluminum and steel construction, control in movement is straightforward and trouble-free.*



### Ease For Caregivers

*Jasmine lifts feature a battery-powered boom and wide-opening base, both controlled through the hand pendant*



### Security

*The stable spring-loaded hanger bar produces an audible tone when the sling is engaged. This assures the caregiver that the sling is properly attached.*



- Cradle
- XL Cradle



- Scale : JLS5

### Invacare® Jasmine™ Full Body Lift

Height at sling hook-up - MAX	74.6"	Battery	24V DC (Rechargeable) 2 Shipped with Unit
Height at sling hook-up - MIN	16.4"	Charger input	100-240V AC
Base width OPEN	46.7"	Charger output/Charging time	29.5 DC Max 6 hours
Base width CLOSED	25.8"	Audio low battery alarm	Yes
Base height (Clearance)	4.8"	Motor safety devices	Anti-Entrapment
Base length	49"	Limited warranty electronics	3 years on Lift, 2 years on Electronics
Caster size (Front/Rear)	4.0"	Emergency stop button	Yes
Weight capacity	500 lb.	Emergency up and down	Yes
Weight out-of-carton	98 lb.		

The Invacare® line of Reliant™ lifts was conceived to help reduce the possibility of caregiver back injury and to ensure dignity in patient handling. These high-quality lifts are comfortable, reliable and integral tools for staff and caregivers. Using the lift for patient handling can help reduce staff injuries, save you money and reinforce safety as a priority in your health care facility. Invacare Reliant lifts support up to 450 pounds, making potentially challenging transfers smooth for the resident and caregiver. The high lift range allows easy access to tubs, chairs, commodes, floors and beds (with at least 4.5" under-bed clearance). Along with functional and innovative lifts, Invacare also offers facility assessment plans to further aid in your safety management program. Our all-encompassing lift system also includes in-service training, videos and an ergonomic safety plan. Our goal is to partner with you in lowering costs and protecting your staff from injury. The sturdy and practical design of Reliant lifts provides the solution you need for success in your quest to provide safe and effective health care.



Ask us about our injury prevention program.



## Invacare® Reliant™ 450 Hydraulic Lift

Model no. RHA450-1 Hydraulic Adjustable Base (shown), RHL450-1 Hydraulic Low Base Adjustable

- Pump mechanism allows transfers of up to 450 lb. with minimal effort
- Comfortable handle placement for ease of use
- Wide base for maximum stability
- Low maintenance
- Limited warranty includes three years on lift, one year on pump

## Invacare® Reliant™ 450 Battery-Powered Lift with Low Base

Model no. RPL450-1 Power with Low Base

- Removable battery easily charges overnight on wall-mounted charging station
- Equipped with a quiet, long-life motor
- Wide lift range for easier transfer
- Wide base for maximum stability
- 4.5" Under bed clearance
- Limited warranty includes three years on lift, one year on battery

## Invacare® Reliant™ 450

Model no. RPA450-1 Power with Adjustable Base



## Reliant Lift Features

- Height range allows lifting from floor and high surfaces
- Low friction casters significantly improve rollability and contribute to caregiver safety
- Removable battery pack eliminates downtime and simplifies the charging process
- Manual lowering for instant response to power loss
- Electronic system includes two 24-volt batteries: one for lift, one for battery-charging station; a manual emergency lowering device; and an anti-entrapment feature if boom meets any resistance while lowering
- Available with power opening base option (model no. RPL450-2)
- Multi-grip push handle is angled to minimize wrist strain
- Base legs adjust easily and lock securely into open position with the padded shifter handle or optional power option
- Total pinch-point protection covers all moving parts for added safety
- Padded swivel bar with 360° rotation and six-point hook-up allows use of Invacare chain-free slings as well as older style slings with chains or straps
- Attractive neutral design blends well into any environment
- Covered base provides protection against wear, dirt and moisture
- Manufactured in an ISO13485 facility



**Invacare® Reliant™ 450 Power Lift with Power Opening Low Base**

Model no. RPL450-2

### Available Parts Kits for Reliant™ Lifts

Description	Part no.	Description	Part no.
Reliant touch-up paint	1075222	Reliant low base replacement kit (manual)	1079810
Reliant replacement batteries	1078276	Reliant sling holder bag (four-pack)	1088911
Reliant swivel bar kits	1143629	Reliant training video: <i>Lifting with Ease</i>	1090823
Extra-wide Reliant swivel bars	1143630	Reliant training video: <i>Standing with Ease</i>	1090824

## Lift Specifications

	Hydraulic Adjustable RHA450-1	Power Adjustable RPA450-1	Hydraulic Low Base RHL450-1	Power Low Base RPL450-1	Power Lift w/ Power Opening Base RPL450-2
<b>Height</b>					
Maximum at sling hook-up	73"	76"	71"	74"	74"
Minimum at sling hook-up	27"	26"	25"	24"	24"
Base height (clearance)	6.8"	6.8"	4.5"	4.5"	4.5"
<b>Base width</b>					
Open	41"	41"	41"	41"	41"
Closed	26.5"	26.5"	26.5"	26.5"	26.5"
Base length	48"	48"	48"	48"	48"
<b>Casters</b>					
Front	5"	5"	3"	3"	3"
Rear	5"	5"	5"	5"	5"
Weight capacity	450 lb.	450 lb.	450 lb.	450 lb.	450 lb.
<b>Product weight</b>					
Out-of-carton	93 lb.	106 lb.	93 lb.	106 lb.	109 lb.
<b>Removable battery pack</b>					
One 24-volt rechargeable sealed		X		X	X
Charger output 24-volt DC		X		X	X
Audible "low battery" alarm		X		X	X
Lifts per charge: 150-300*		X		X	X

\*Varies with lift range and load.

Complete instructions for lift usage and sling procedures are found in the Invacare Operating Manual. Only Invacare slings and accessories should be used on Invacare lifts.



### Hand Pendant

- Ergonomic control with heavy-duty cord
- Convenient pendant hook allows attachment and storage on multiple areas of lift



### Rear Locking Brakes

- Locking feature on 5" rear casters is standard on all models



### Invacare® Reliant™ Digital Scale

Model no. RLS6

- Retrofits on all Reliant 450/600 lifts. Model no. 9805 requires Reliant swivel bar (Part no. 1064518)
- Easy to operate, four-button display
- Automatic shut-off feature prolongs battery life
- Two-year limited warranty



### Manual Lowering

- Manual emergency lowering feature gently and safely lowers resident in case of total power loss
- Essential safety feature
- Manual lowering is easy and effortless. Simply insert the end of a ball point pen into the hole marked "emergency" or lift on the accessible ring-pull



### Electronics

- Removable battery box is conveniently located on mast; it features an emergency OFF button and beeps when battery needs to be recharged; requires one 24-volt battery
- Quick-release battery eliminates downtime
- Anti-entrapment feature stops motion if boom meets resistance while lowering
- Heavy-duty hand pendant and cord



### Charging Station

- One 24-volt battery on mast with quick release
- Battery can be replaced immediately with second battery in wall-mounted charger
- UL listed and CSA certified



Designed to meet the special needs of your patients weighing up to 600 pounds, the Invacare® Reliant™ 600 heavy-duty lift is secure and sturdy, providing a safe alternative to manual lifting. Both durable and functional, the Reliant 600 is also a reassuring and comfortable patient lift. When answering the needs of every patient is your priority, this is your wisest choice.



Model no. RPL600-1 Power lift with low base.

## Features

- High lift range allows transfer to high surfaces
- Low friction casters significantly improve rollability and contribute to caregiver safety
- Designed to meet the needs of the growing bariatric population up to 600 lb.
- Manual lowering for instant response to power loss
- Unique sling fabric designed to provide the utmost in comfort and strength
- Available with power opening base (model no. RPL600-2)
- Essential device for safe patient handling in hospitals and LTC (long-term care) facilities
- Limited warranty includes three years on lift, one year on electric components
- Rear locking casters are standard
- Manufactured in an ISO13485 facility

## Lift Specifications

	Power Adjustable RPA600-1	Power Low Base RPL600-1	Power Lift with Pwr.Opening Base RPL600-2
<b>Height</b>			
Maximum at sling hook-up	70"	68"	68"
Minimum at sling hook-up	29.5"	28"	28"
Base height (clearance)	6.8"	4.5"	4.5"
<b>Base width</b>			
Open	41"	41"	41"
Closed	26.5"	26.5"	26.5"
Base length	48"	48"	48"
<b>Casters</b>			
Front	5"	3.5"	3.5"
Rear	5"	5"	5"
Weight capacity	600 lb.	600 lb.	600 lb.
<b>Product weight</b>			
Out of carton	112 lb.	112 lb.	115 lb.
Shipping	138 lb.	138 lb.	141 lb.



Power lift with power opening low base.

Model no. RPL600-2





## Invacare® Reliant™ Digital Scale

Model no. RLS6

- Precision scale mounted on swivel bar accurately measures weights up to 600 lb.
- Retrofits on all Reliant™ 450/600 lifts. Model 9805 requires Reliant swivel bar
- Easy-to-operate, four-button display
- Automatic shut-off feature prolongs battery life
- Two-year limited warranty

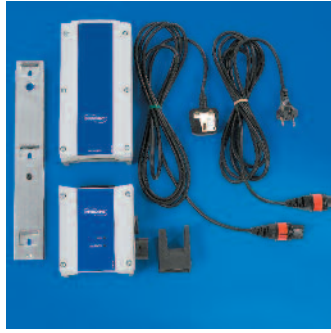

## Charging Station

- One 24-volt battery on mast with quick release
- Battery can be replaced immediately with second battery in wall-mounted charger
- UL listed and CSA certified



## Manual Lowering

- Manual emergency lowering feature gently and safely lowers resident in case of total power loss
- Essential safety feature
- Manual lowering is easy and effortless. Simply insert the end of a ball point pen into the hole marked "emergency"; lift on the accessible ring-pull

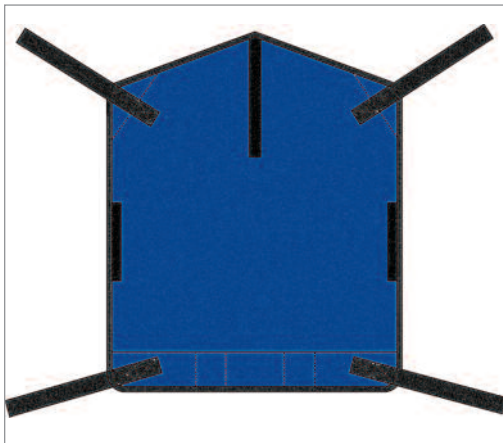

Model no. R140 Mesh sling

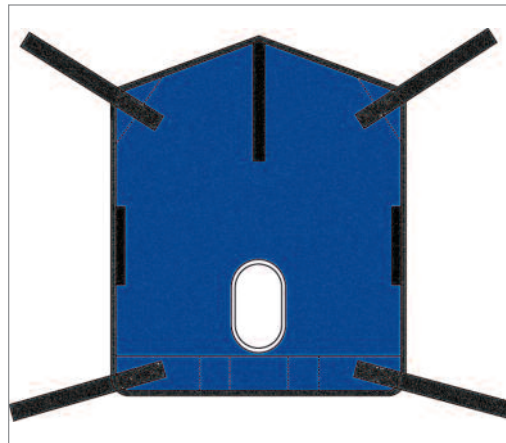

Model no. R141 Mesh sling with commode opening

## Sling Specifications

	R140	R141
Width	45"	45"
Commode opening	n/a	7"
Length	55"	55"
Commode opening	n/a	13"
Weight capacity	600 lb.	600 lb.
<b>Product weight</b>		
Out-of-carton	2.2 lb.	2.1 lb.
Shipping	2.7 lb.	2.6 lb.

Complete instructions for lift usage and sling procedures are found in the Invacare Operating Manual. Only Invacare slings and accessories should be used on Invacare lifts.

Too often, manual patient transfers lead to caregiver back injuries. The Invacare 9805 and 9805P hydraulic lifts were created to make handling situations safer and affordable for everyone involved. With their slim design, these hydraulic lifts are versatile enough to use for most any and all patient transfers. The features of the 9805 and 9805P include a padded swivel bar and push handle, a 450-pound weight capacity, durable chrome-plated construction or painted finish and 360° patient rotation without side-to-side sway. Lightweight construction and easy disassembly allow for quick transport and setup. Indispensable to patients and caregivers alike, the 9805 and 9805P offer safety, comfort and stability. Most important, they offer peace of mind, which makes them valuable assets to your health care facility.



## Features

- Six-point swivel bar attachment easily adapts to all sling styles and positions
- Low friction casters significantly improve rollability and contribute to caregiver safety
- 20"-64" range allows for patient to be picked up from lying position on floor
- Pump handle can rotate from side to side for convenience of attendant
- Offset mast and boom style provide better lift path, maximizing full travel range
- Swivel bar and pump handle are padded for comfort
- Elongated handle design serves a broad range of operator heights and offers improved handling ability
- Limited warranty includes three years on lift, one year on hydraulic pump

**Base**

Model no. 9884 Adjustable base

- Completely enclosed cam moves legs of adjustable base
- Offers obstruction-free operation; ideal for cleaning
- Screw-in pin at mast base provides maximum stability and prevents removal of mast



*Hydraulic pump raises boom from lowest to highest height with minimal physical effort.*

## Lift Specifications

Model no. 9805, 9805P (Painted)

Height	
Maximum at sling hook-up	64"
Minimum at sling hook-up	20"
Base height (clearance)	6.5"
Base width	
Open	42.25"
Closed	22"
Base length	46.75"
Casters	
Front	5"
Rear	5"
Weight capacity	450 lb.
Product weight	
Out-of-carton	68 lb.
Shipping	85 lb.

## Standard Slings

Model no.	Chain or Strap Assembly Kit (required for standard slings)		
9070	sling strap assembly kit		
9071	sling chain assembly kit		
Model no.	Fabric/Style	Length	Width
9042	solid polyester/without commode	40.5"	29"
9043	solid polyester/with commode	40.5"	29"
9046	mesh polyester/without commode	40.5"	29"
9047	mesh polyester/with commode	40.5"	29"

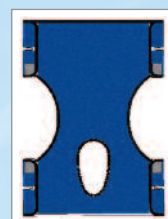

Standard sling

**NEW**

We leave the lifting to the lift. For residents who need assistance in standing, Roze stand-up model lifts are expressly designed to promote independence for the resident while at the same time relieving the lifting burden from the operator.



**Strength Capacity**

The unique height-adjustable kneepad and 450 pound weight capacity easily accommodates the majority of residents in your facility.



**Ease of Use**

With a large push handle, lighter steel and aluminum construction, and simple sling attachment, it is easy to accomplish everyday transfers.



**Accommodating**

For those who only need help rising, simply remove the footplate.



**Maneuverability**

A small footprint combined with lighter weight aluminum and steel construction provide easy maneuverability.



**Invacare® Roze™ Stand-Up Lift**

Height at sling hook-up - MAX	63.5"	Battery	24V DC (Rechargeable) 2 Shipped with Unit
Height at sling hook-up - MIN	37"	Charger input	100-240V AC
Base width OPEN	44"	Charger output/Charging time	29.5 DC Max 6 hours
Base width CLOSED	26"	Audio low battery alarm	Yes
Base height (Clearance)	4.8"	Motor safety devices	Anti-Entrapment
Base length	38.8"	Limited warranty electronics	3 years on Lift, 2 years on Electronics
Overall height	49.1"	Emergency stop button	Yes
Overall length	42"	Emergency up and down	Yes
Overall width	26"		
Caster Size (Front/Rear)	4.0"		
Weight capacity	450 lb.		
Weight out-of-carton	117 lb.		

Comfortable and secure, the Invacare® Get-U-Up™ stand-up lift is the answer to your patient transfer needs. Its ergonomic styling and easy maneuverability make the Get-U-Up an ideal product for every day patient handling. The Get-U-Up helps ensure caregiver security and patient peace of mind. Ideal for use with partial weight-bearing patients as well as those needing rehabilitation support, the Invacare Get-U-Up stand-up lift offers safety, comfort and stability.



Model No. GHS350

## Features

- Innovative adjustment features adapt to a wide variety of body sizes and shapes. That means comfort at any height, width and weight range up to 350 lb.
- Low friction casters significantly improve rollability and contribute to caregiver safety
- Multi-function slings allow for quick toileting, stand-assist or full-support seated transfer
- Adjustable leg support features a soft pad with lateral contour that secures legs in multiple positions for comfort at any height
- Retractable, non-slip footplate provides stable base for transfer
- Under-bed clearance of 4.5" allows accessibility to most homecare-style beds
- Ergonomic features make it ideal for toileting transfers, as well as dependent and rehabilitation purposes
- Fast, simple sling attachment that protects against accidental disengagement; wide push handle, good access for clothing removal; and comfortable slings with extended back support that prevents pressure in the under arm area
- Pump handle can rotate from side to side for convenience of caregiver
- Limited warranty includes three years on the lift, one year on the hydraulic pump

## Specifications

Model no.	GHS350
<b>Height</b>	
Maximum at sling hook-up	65"
Minimum at sling hook-up	36"
Base height (clearance)	4.5"
<b>Base width</b>	
Open	37"
Closed	23"
<b>Base length</b>	40.5"
<b>Casters</b>	
Front	3"
Rear	5"
<b>Weight capacity</b>	350 lb.
<b>Product weight</b>	
Out-of-carton	88 lb.
Shipping	100 lb.

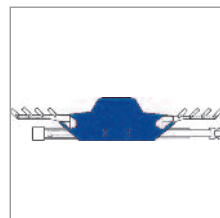

Model no. R130 Standing sling

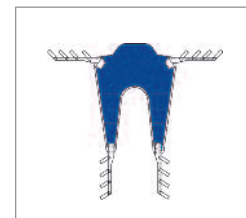

Model no. R134 Transfer sling

## Sling Specifications

	R130	R134
Width	60"	34"
Overall Length	16"	42"
<b>Product weight</b>		
Out-of-carton	1.1 lb.	1.3 lb.
Shipping	1.6 lb.	1.8 lb.



Shown with R130 Standing sling

## Features

- Innovative adjustment features adapt to a wide variety of body sizes and shapes. That means comfort at any height, width and weight range up to 350 lb.
- Low friction casters significantly improve rollability and contribute to caregiver safety
- Multi-function slings allow for quick toileting, stand assist or full-support seated transfer
- Adjustable leg support features a soft pad with lateral contour that secures legs in three positions for comfort at any height
- Wide, non-slip footplate provides stable base for transfer
- Under-bed clearance of 4.5" allows accessibility to most nursing home, hospital and home care bed styles
- Available with power opening base (model no. RPS350-2)
- Removable battery eliminates downtime
- Ergonomic features make it ideal for toilet transfers, as well as for dependent and rehabilitation purposes
- Features include fast, simple sling attachment that protects against accidental disengagement; wide push handle; good access for clothing removal; and comfortable slings with extended back support that prevents pressure in the under-arm area
- Adjustable leg strap option secures leg against knee pad for optimum positioning on footplate
- Limited warranty includes three years on lift, one year on motor
- Manufactured in an ISO13485 facility



## Electronics

- Removable battery box is conveniently located on mast; it features an emergency OFF button and recharge indicator (with audible recharge alarm)
- Quick-release battery eliminates downtime
- Anti-entrapment feature stops motion if boom meets resistance while lowering
- Heavy-duty hand pendant and cord
- Includes two batteries and a recharging station

## Specifications

Model no.	Pwr. Base RPS350-1	RPS350-2
<b>Height</b>		
Maximum at sling hook-up	63.7"	63.7"
Minimum at sling hook-up	39.6"	39.6"
Base height (clearance)	4.5"	4.5"
<b>Base width</b>		
Open	36.8"	35.8"
Closed	25.7"	25.7"
<b>Base length</b>	35.5"	35.5"
<b>Casters</b>		
Front	3"	3"
Rear (locking)	5"	5"
<b>Weight capacity</b>	350 lb.	350 lb.
<b>Product weight</b>		
Out-of-carton	115 lb.	118 lb.
Shipping	125 lb.	128 lb.

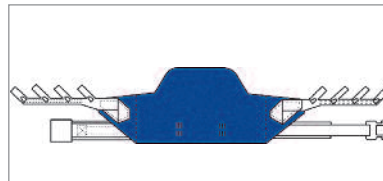

*Model no. R130 Extra-large standing sling*  
Sling model numbers R130 and R134 are also compatible with the Reliant 440 lift. Complete instructions for lift usage and sling procedures are found in the Invacare operating manual. Only Invacare® slings and accessories should be used on Invacare® lifts.

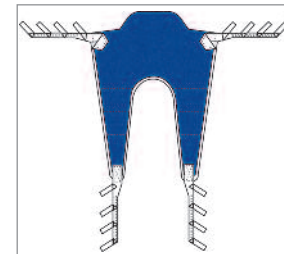

*Model no. R134 Extra-large transfer sling*

## Sling Specifications

	R130	R134
Width	60"	34"
Overall Length	16"	42"
<b>Product weight</b>		
Out-of-carton	1.1 lb.	1.3 lb.
Shipping	1.6 lb.	1.8 lb.



Comfortable and secure, the Invacare® Reliant™ 440 Stand-Up lift is the answer to your patient handling needs. The ergonomic styling and easy maneuverability make the Reliant 440 an ideal product for everyday patient transfers. With its numerous safety features, the Reliant 440 Stand-Up Lift helps ensure caregiver security and resident peace of mind. Ideal for use with weight-bearing of fully dependent patients, as well as for those needing rehabilitation support, the Invacare Reliant 440 Stand-Up lift will be a valuable addition to your safety-management system.

## Features

- Innovative adjustment features adapt to a wide variety of body sizes and shapes. That means comfort at any height, width and weight range up to 440 lb.
- Power-opening base operated with hand pendant allows for single-caregiver adjustments
- Low friction casters significantly improve rollability and contribute to caregiver safety
- Multi-function slings allow for quick toileting, stand assist or full-support seated transfer
- Adjustable leg support features a soft pad with lateral contour that secures legs in comfort
- Wide, non-slip footplate provides stable base for transfer and may be removed for standing assistance
- Removable battery eliminates downtime
- Under-bed clearance of 5" allows accessibility to most nursing home, hospital and home care bed styles
- Ergonomic features make it ideal for toilet transfers, as well as for dependent and rehabilitation purposes (optional WT200 walking tutor attachment)
- Fast, simple sling attachment that protects against accidental disengagement; wide push handle; good access for clothing removal; and comfortable slings with extended back support that prevents pressure in the under-arm area
- Adjustable leg strap option secures leg against knee pad for optimum positioning on footplate
- Limited warranty includes three years on lift, one year on motor

## Specifications

<b>Model no.</b>	<b>RPS440-1</b>
<b>Height</b>	
Maximum at sling hook-up	67"
Minimum at sling hook-up	39"
Base height (clearance)	5"
<b>Base width</b>	
Open	44"
Closed	26"
<b>Base length</b>	
	41.5"
<b>Casters</b>	
Front	4"
Rear (locking)	4"
<b>Weight capacity</b>	
	440 lb.
<b>Product weight</b>	
Out-of-carton	117 lb.
Shipping	167 lb.

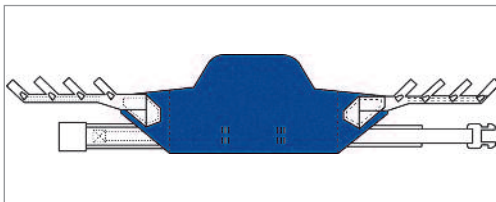

Model no. R131 Extra-large standing sling

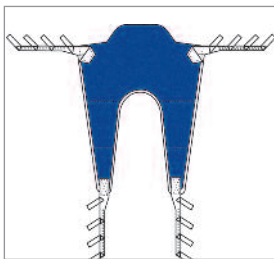

Model no. R136 Extra-large transfer sling

Sling model numbers R131 and R136 are also compatible with the Reliant 350 lift. Complete instructions for lift usage and sling procedures are found in the Invacare operating manual. Only Invacare® slings and accessories should be used on Invacare® lifts.

## Sling Specifications

	<b>R131</b>	<b>R136</b>
Width	84"	46"
Overall Length	16"	52"
<b>Product weight</b>		
Out-of-carton	1.3 lb.	1.6 lb.
Shipping	2.0 lb.	2.1 lb.



Model RPS440-1 with WT200 Walking Tutor Attachment (Optional)

## Electronics



- Removable battery box is conveniently located on mast; it features an emergency OFF button and recharge indicator (with audible recharge alarm)
- Quick-release battery eliminates downtime
- Heavy-duty hand pendant and cord operates boom and base
- Anti-entrapment feature stops motion if boom meets resistance while lowering
- Includes two batteries and a recharging station



The new Invacare® Premier Series slings balances solutions for any transfer. We say that with confidence because these slings were developed in collaboration with Occupational and Physical therapists. Invacare Premier slings are available in a wide variety of styles and can be adjusted to ensure a comfortable and secure fit for the resident. Clearly labeled slings and easy attachment points make it simple for the caregiver to quickly attach the sling and lift the resident.

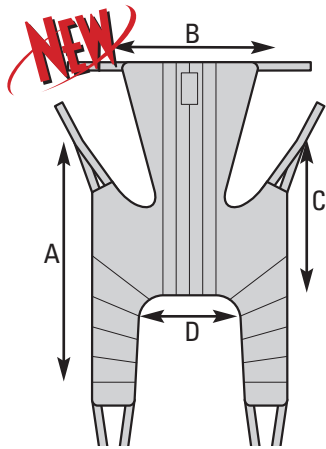

### Universal High SlingPlus

Supports the whole body and head in transfers to/from seated or lying position. Offers a comfortable recline for those with limited head, trunk or hip control. Allows arms to hang outside the sling.

Compatible with the following lifts

- Jasmine™
- Reliant™ 450, 600

SIZE	PRODUCT NUMBER / MATERIAL				
	A	B	C	D	Polyester Fabric
S	54.4"	33.1"	34.7"	13.4"	2485960
M	59.5"	37.4"	36.6"	17.7"	2485961
L	62.3"	43.3"	38.2"	22.1"	2485962
XL	62.6"	46.9"	38.2"	24.8"	2485963

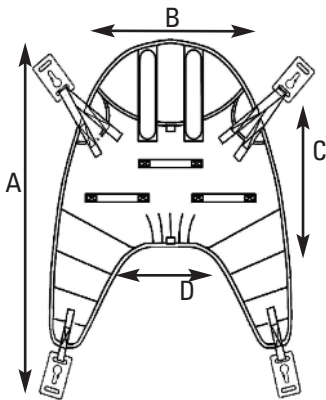

### Cradle Sling

Designed for use with our new Jasmine lift. Comfort and support of the whole body and head are crucial for those with head, trunk and hip concerns. 4-point attachment clips onto the cradle bar for best positioning in horizontal-to-seated or seated-to-seated transfers. Head support is optional by removing rigidizers.

Compatible with the following lifts

- Jasmine™ with cradle accessory

SIZE	PRODUCT NUMBER / MATERIAL				
	A	B	C	D	Polyester Fabric
S	42.6"	33.1"	28.8"	15.0"	3483777
M	55.9"	39.4"	32.7"	15.8"	3483778
L	61.1"	43.3"	36.2"	20.1"	3483779
XL	66.2"	45.3"	36.2"	21.7"	3485949

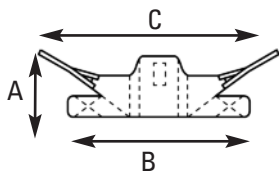

### Stand Assist Sling

Designed for use with our Roze and Reliant 350 and 440 lifts, the Stand Assist Sling offers a comfortable and safe transfer for those who have some weight bearing ability, but cannot stand independently. The sling is well-padded and features non-slip material on the side that touches the resident to assure a comfortable transfer position.

SIZE	PRODUCT NUMBER / MATERIAL			
	A	B	C	Polyester Fabric
S	10.2"	33.1"	34.7"	2484685
M	13.0"	35.3"	46.1"	2484686
L	14.2"	37.4"	50.0"	2484687
XL	14.2"	40.2"	71.3"	2484688

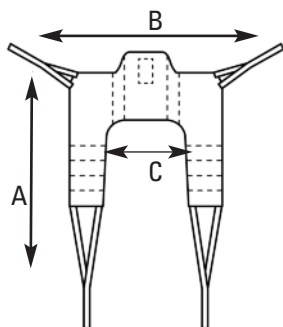

### Transfer Stand Assist Sling

Also designed for optimal use with our Roze and Reliant 350 and 440 lifts, this high-quality sling provides simple seated transfer for residents with minimal weight bearing ability.

Compatible with the following lifts

- Roze
- Reliant™ 350, 440

SIZE	PRODUCT NUMBER / MATERIAL			
	A	B	C	Polyester Fabric
S	33.9"	33.1"	9.5"	2484689
M	40.2"	35.3"	10.2"	2484690
L	46.5"	37.4"	13.0"	2484691
XL	48.5"	40.2"	13.8"	2485117

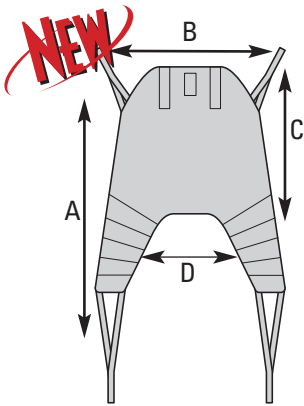

## Universal High Sling

Supports the whole body and head in transfers to/from seated or lying position. Offers a comfortable recline for those with limited head, trunk or hip control. Universal High Sling allows arms to hang outside the sling.

Compatible with the following lifts  
 • Jasmine™ • Reliant™ 450, 600

PRODUCT NUMBER / MATERIAL

SIZE	A	B	C	D	Polyester Fabric	Spacer Fabric
S	42.6"	33.1"	28.8"	15.0"	2483777	2485956
M	55.9"	39.4"	32.7"	15.8"	2483778	2485957
L	61.1"	43.3"	36.2"	20.1"	2483779	2485958
XL	66.2"	45.3"	36.2"	21.7"	2485949	2485959

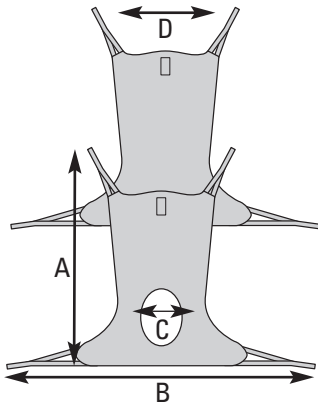

## Comfort Sling and Comfort Sling with Commode Opening

Amputees and residents with chronic or postural pain have delicate needs that may require a constant seated position. Our Comfort Slings transfer them from a horizontal to seated position, with an additional model if toileting is also required.

Compatible with the following lifts  
 • Jasmine™ • Reliant™ 450, 600

PRODUCT NUMBER / MATERIAL

SIZE	A	B	C	D	Comfort Sling		Comfort Sling w/Toileting Opening	
					Net Fabric	Spacer Fabric	Polyester Fabric	Net Fabric
S	45.3"	41.4"	21.7"	40.2"	2485968	2485554	2451092	2451097
M	55.2"	46.1"	24.0"	46.5"	2485969	2485777	2451093	2451098
L	57.1"	50.8"	26.4"	50.4"	2485970	2485778	2451094	2451099
XL	57.5"	52.4"	29.6"	57.9"	2485947	2451090	2451095	2451100

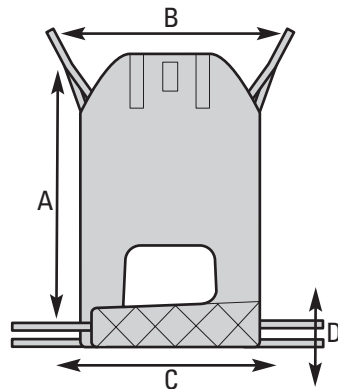

## Easy-Fit Sling

For those with more challenging physical disabilities, including amputees, this sling supports the whole body and head in an upright position with separate leg supports and optimal hip position.

Compatible with the following lifts  
 • Jasmine™ • Reliant™ 450, 600

PRODUCT NUMBER / MATERIAL

SIZE	A	B	C	D	Polyester Fabric
S	44.5"	29.9"	25.2"	7.1"	2451102
M	47.3"	31.5"	26.6"	7.5"	2451103
L	50.0"	33.9"	28.4"	8.3"	2451104
XL	54.8"	37.0"	30.7"	8.7"	2451105

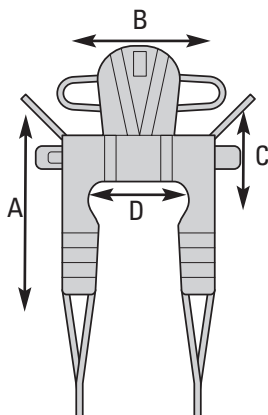

## Dress Toileting High Sling

Featured belt offers secure support and positioning. Easy-to-apply Dress Toileting High Sling is suitable for seat-to-seat transfers and dressing or undressing during transfers to toilet. Dress Toileting High Sling is specially designed for users with reduced head control.

Compatible with the following lifts  
 • Jasmine™ • Reliant™ 450 & 600

PRODUCT NUMBER / MATERIAL

SIZE	A	B	C	D	Polyester Fabric
S	34.3"	28.0"	7.9"	16.9"	2478444
M	37.4"	31.5"	9.1"	19.3"	2478445
L	40.2"	35.5"	9.1"	23.6"	2478446
XL	43.3"	42.6"	10.6"	29.9"	2484780

# Invacare® Reliant™ Full Body and Stand-Up Lift Slings

Invacare® Reliant™ slings come in a wide array of styles to meet a variety of client needs, and the new, improved overall design makes them all easier than ever to position. Reliant slings feature a unique, fully padded fabric that forms a soft yet supportive surface. The soft, brushed lining helps prevent sliding for ultimate comfort and skin protection, and the new, stretch-resistant feature helps the slings hold their shape for superior support and ease of positioning. For clients and caregivers alike, Invacare Reliant slings are designed with comfort and safety in mind.



Invacare® Reliant Full-Body Slings



Invacare® Reliant Full-Body Slings with Commode Opening



Invacare® Reliant Divided-Leg Slings with Headrest



Invacare® Reliant Toileting Sling with Belt

- Sling size and fit can vary significantly depending on patient weight and girth. These are general guidelines. Consult physician before sling selection.
- Washing instructions are on each sling label. Washing temperatures should not exceed 180° F. Air-dry or dry at low temperatures.
- All slings are constructed of polyester fabrics which can be used in wet or dry environments.
- All Invacare® slings were designed specifically for use with Invacare® brand lifts for proper usage and optimal performance. To receive the maximum benefits from our products, please see our size guide, product specs and operator manuals for solutions that best suit the needs of your facility. [Insert other legal line as determined in previous collateral]

## Sling Sizes

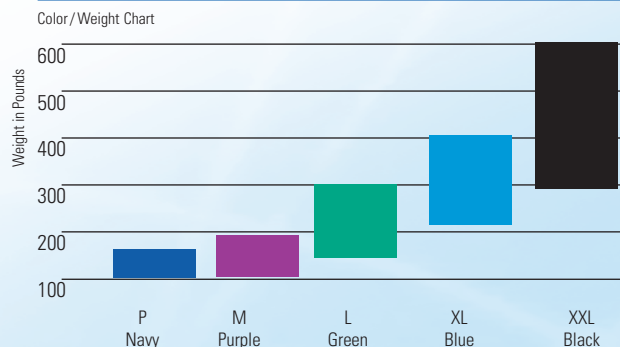

## Full Body Sling With/Without Commode Opening (CO)

An easy sling to use while transferring the resident from the bed to a wheelchair, toilet or shower-chair or from floor to bed. It offers total head and neck support and the padded lower section provides additional under-thigh comfort and support. Use the full body sling for residents who are totally dependent, partially-dependent, non-weight bearing, very heavy or have limited head control. Use this sling for amputee residents (in a reclined position).

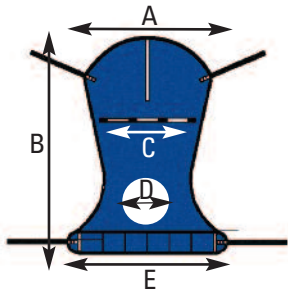

Fits the following lifts : Reliant™ 450, 600

Model No.	R110	R111	R140	R114	R115	R116	R141	R112	R113	R117
	Mesh	Mesh	Mesh	Mesh w/CO	Mesh w/CO	Mesh w/CO	Mesh w/CO	Solid Fabric	Solid Fabric	Solid Fabric
Size	M	L	XXL	M	L	XL	XXL	M	L	XL
A	41.4"	45.5"	45"	41.5"	45.5"	45.5"	45"	41.5"	45.5"	45.5"
B	53.3"	58.3"	55"	53.3"	58.3"	63.2"	55"	54.7"	60.3"	65.3"
C	23.9"	26.3"	45"	23.9"	26.3"	26.3"	45"	23.2"	26.3"	26.1"
D	N/A	N/A	N/A	6"	7"	7"	7"	N/A	N/A	N/A
E	43.7"	47.7"	45"	43.7"	47.7"	47.7"	45"	41.8"	45"	45"
Weight Capacity	450 lb.	450 lb.	600 lb.	450 lb.	450 lb.	450 lb.	600 lb.	450 lb.	450 lb.	450 lb.

## Divided Leg Sling

The divided leg sling is a secure, easy-to fit general purpose sling, designed for the majority of sling users. Use the divided leg sling for residents who are totally dependent, partially dependent, non-weight bearing, very heavy or have limited head control. Use this sling when transferring the resident from the bed to a wheelchair, recliner or showerchair. The large opening also accommodates toileting.

Fits the following lifts : Reliant™ 450, 600

Model No.	R100P	R100	R101	R102
Size	S	M	L	XL
A	33"	37.5"	41"	44.5"
B	29.16"	35.66"	40.66"	43.16"
C	12"	17"	20.5"	22.6"
Weight Capacity	450 lb.	450 lb.	450 lb.	450 lb.

## Solid Fabric Toileting Sling

The Toileting Sling offers superb access for quick toileting and hygiene. It is easy to place and remove in a bed or chair situation. The fully padded design supports the back, offers under thigh comfort and allows for removal of clothing. Color coded positioning straps help align the sling properly on the hanger bar. Note: This sling requires the patient to have FULL head and neck control.

Fits the following lifts : Reliant™ 450, 600

Model No.	R121
Size	L
A	36"
B	44.7"
C	20.5"
Weight Capacity	450 lb.

